





new life radiology

PRESENTA | PRESENTS | PRESENTE

# Opera

by new life radiology

-  La nostra nuova OPERA, il tuo nuovo PANORAMA
-  Our new OPERA, your new PANORAMA
-  Notre nouvelle OPERA, votre nouveau PANORAMA





Opera  
by new life radiology



Opera  
by new life radiology



- 🇮🇹 LA FAMIGLIA DI SOLUZIONI PANORAMICHE
- 🇬🇧 THE FAMILY OF PANORAMIC SOLUTIONS
- 🇫🇷 LA FAMILLE DES SOLUTIONS PANORAMIQUES

Opera  
2D CEPH | 3D CEPH



Opera  
2D | 3D

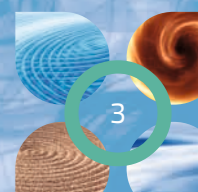

# Opera

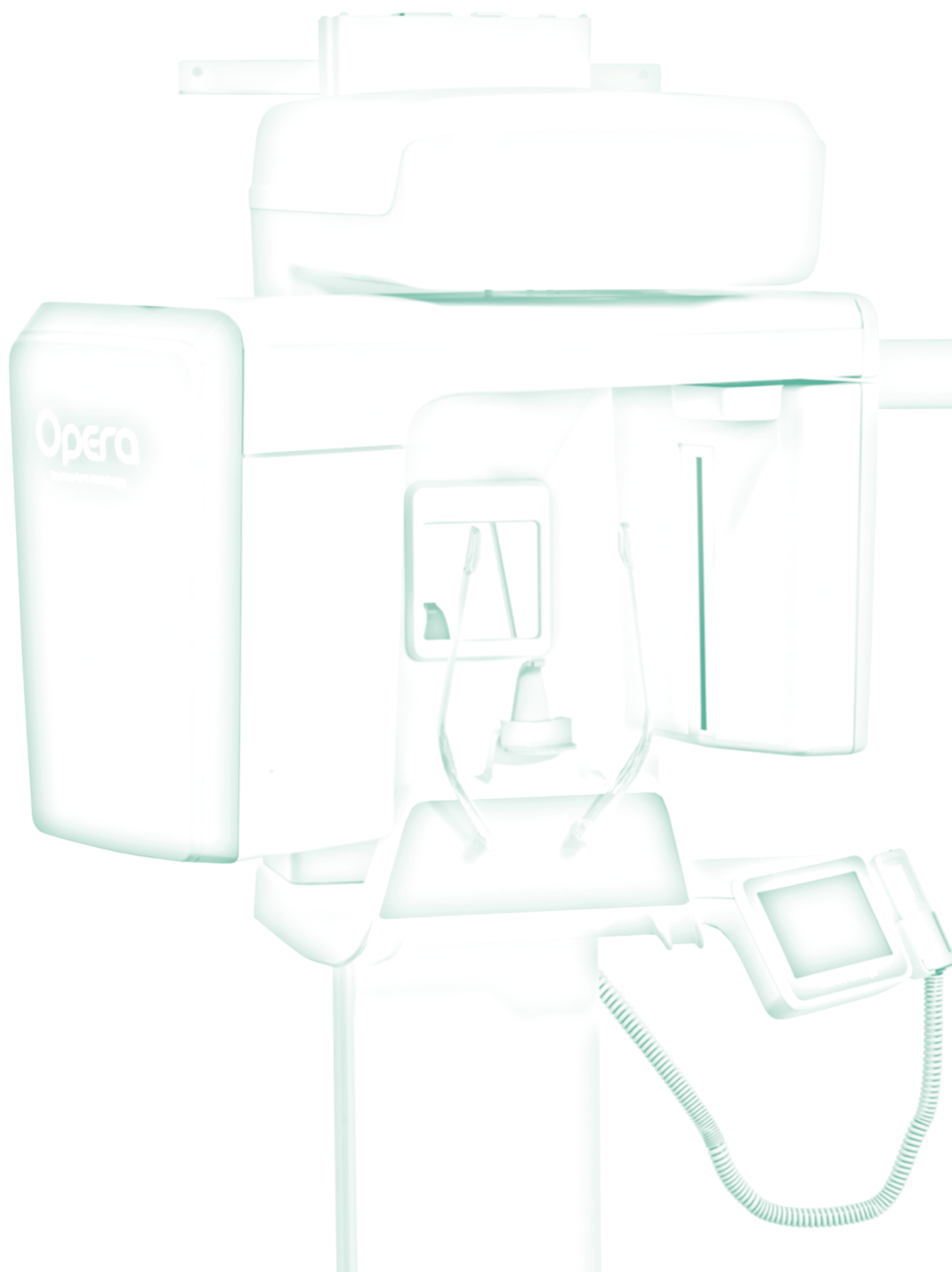

## Perché scegliere OPERA?

- Disegno ergonomico
- Facile posizionamento
- Utilizzo intuitivo
- Alta qualità delle immagini anche senza CEPH
- Scegli la versione 2D e decidi tu "se" e "quando" fare l'upgrade

## Why choosing OPERA?

- Ergonomic design
- Easy positioning
- Intuitive Use
- High Quality Images even without CEPH
- Choose 2D version now and decide "if" and "when" upgrade

## Pourquoi choisir OPERA?

- Design ergonomique
- Positionnement facile
- Utilisation intuitive
- Qualité d'image élevée même sans CEPH
- Choisissez la version 2D et décidez "si" et "quand" mettre à niveau

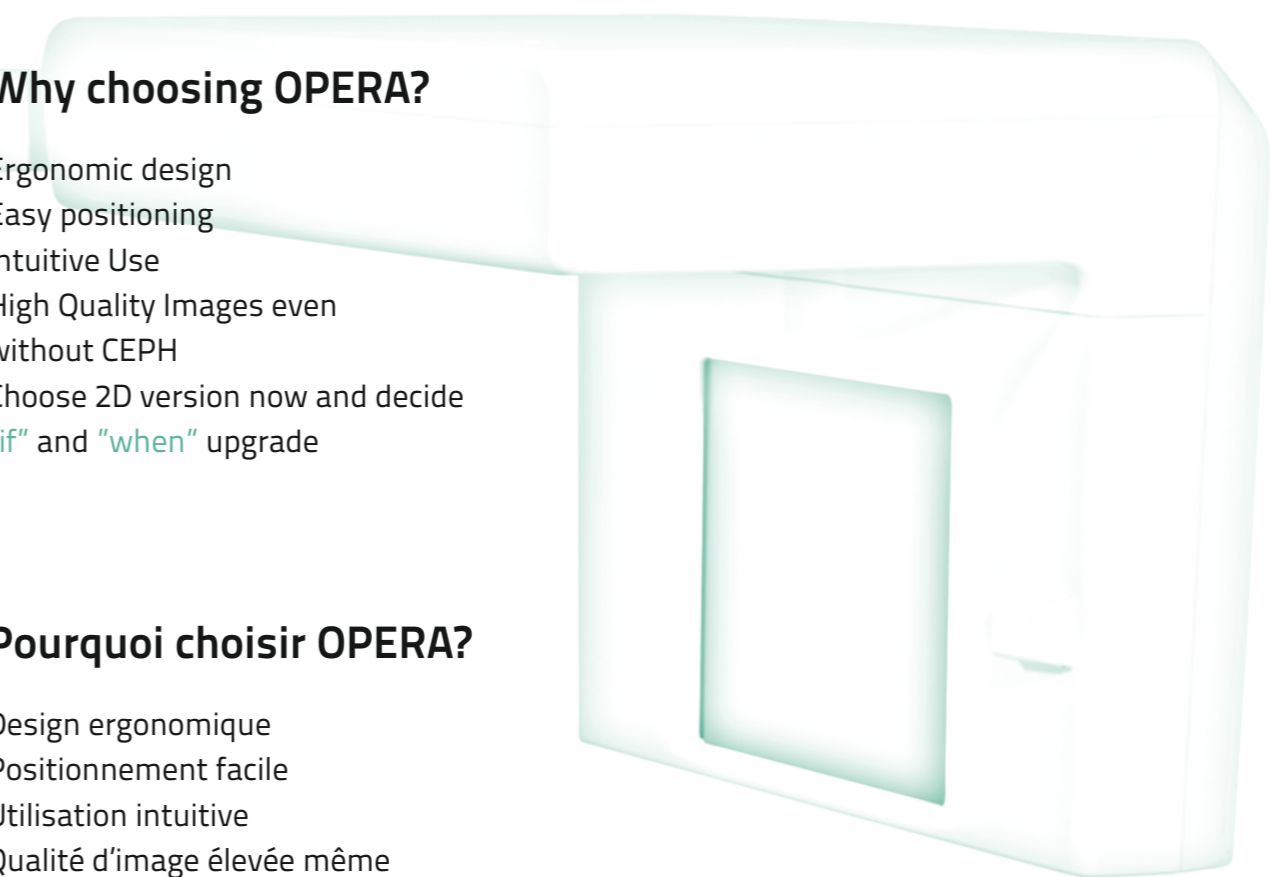



Non **UN** Panoramico...  
Not **A** Panoramico...  
Pas **UN** Panoramique...

**IL** Panoramico  
**THE** Panoramico  
**LE** Panoramique

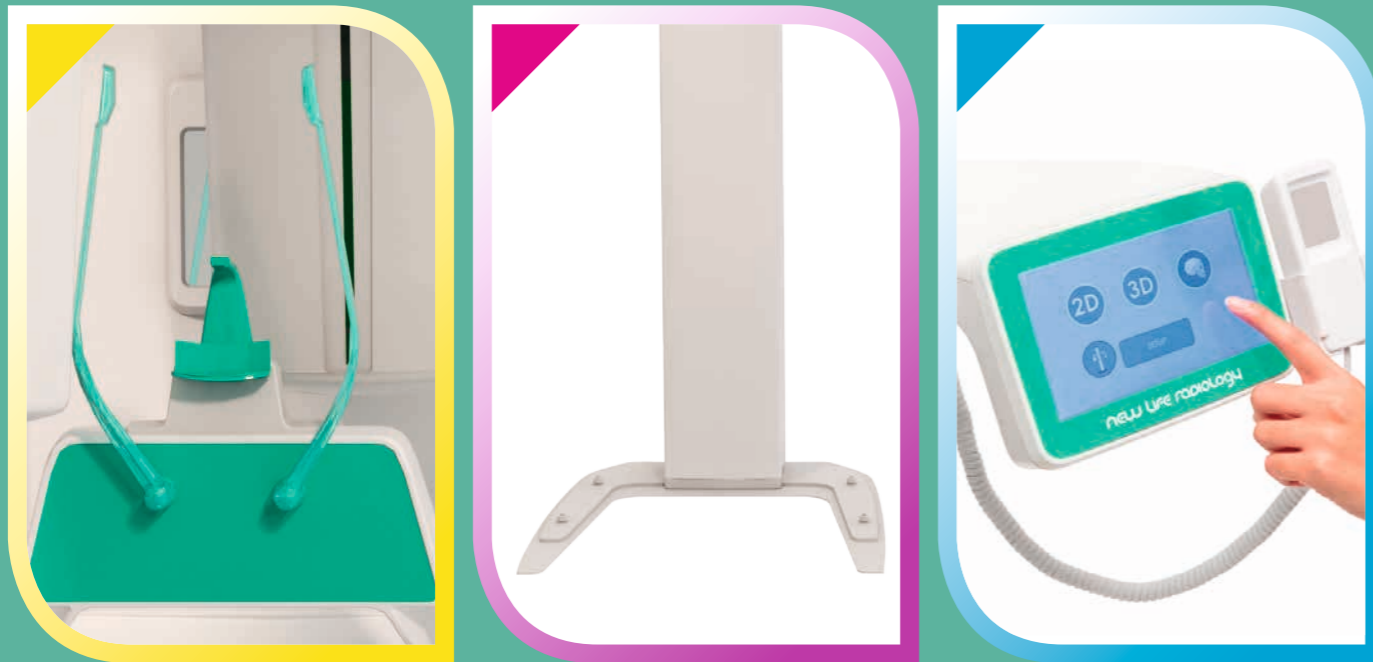

#### DIAGNOSI CHIARA FIN DALLA PRIMA RADIOGRAFIA

OPERA è il sistema integrato per l'acquisizione e la gestione di immagini digitali 2D, 3D e cefalometriche in alta definizione. Si tratta di un Panoramico digitale di facile utilizzo che garantisce immagini di alta qualità, perfette per una diagnosi chiara e precisa fin dalla prima radiografia.

#### GENERATORE IN ALTA FREQUENZA CON MACCHIA FOCALE 0.5 MM

OPERA impedisce l'emissione di radiazioni superflue, grazie al generatore in alta frequenza ad emissione pulsata con macchia focale 0.5mm. Con OPERA by New Life Radiology, l'acquisizione di immagini in alta definizione con rotazione di 230 gradi avviene in soli 15s.

#### POSIZIONAMENTO VELOCE E STABILE PER UN RISULTATO ANCORA PIU' PRECISO

Il posizionamento del Paziente è facile e veloce. Morso, mentoniera e fasci laser ne assicurano il centraggio perfetto. Lo specchio aiuta l'Operatore ad eseguire il posizionamento in modo rapido e corretto. OPERA by New Life Radiology pone molta attenzione al Posizionamento: un corretto allineamento del Paziente determina una migliore qualità dell'immagine, minor tempo per l'esame ed una riduzione dell'esposizione ai raggi.

#### BASAMENTO METALLICO AUTOPORTANTE

Maggiore stabilità è sinonimo d'immagini di migliore qualità. In quest'ottica, il basamento metallico autoportante di OPERA evita che il Paziente si muova, causando distorsioni nell'immagine e rende più stabile sia Paziente che il Panoramico.

#### TOUCHSCREEN 7 POLLICI A COLORI

Dall'ampio screen l'Operatore ha accesso a tutti i comandi e le funzioni per configurare facilmente il Panoramico durante la fase di posizionamento del Paziente. Il flusso di lavoro è agevolato dal pannello di controllo dal design ergonomico con simboli intuitivi; la grandezza dello screen è ideale per visualizzare velocemente le icone e navigare nel menu.

#### PANRAD MULTI-UTENTE

OPERA viene fornito con PANRAD, il Software per l'elaborazione e la gestione delle immagini: nonostante la sua gamma completa di funzioni, PANRAD è estremamente facile da usare ed aiuta l'Operatore nell'utilizzo di OPERA.

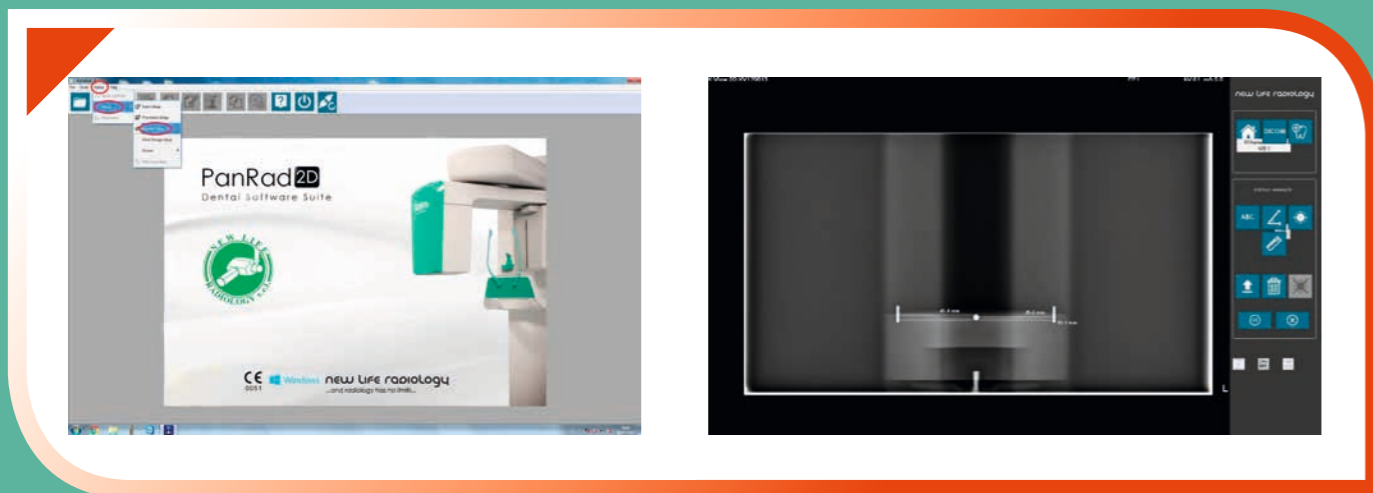

# OPERA

## UK CLEAR DIAGNOSIS AT FIRST VIEW

OPERA is the integrated System to acquire and manage 2D, 3D and Cephalometric HD Digital Images. It's an easy-to-use Digital Panoramic Unit which guarantees High Quality Images, precise and consistent for a **clear Diagnosis on the first x-ray**.

## DC GENERATOR WITH 0.5 MM FOCAL SPOT

OPERA **avoids the emission of unnecessary radiations**, thanks to the **high frequency** pulsed emission generator with **0.5mm focal spot**. With OPERA by New Life Radiology, the acquisition of HD images rotating 230 degrees takes **only 15 seconds**.

## FAST AND STABLE POSITIONING FOR A MORE PRECISE RESULT

Patient positioning can be done quickly and easily. Bite block, chin rest and laser beams ensure perfect Patient centering. Mirror supports the Operator to perform correct and fast. OPERA by New Life Radiology pays a lot of attention on Positioning: **a correct Patient alignment means better image quality, less time for the examination and reduced X-Ray exposure**.

## METALLIC FREE-STANDING BASEPLATE

More stability means better quality images. With this view, OPERA's metallic baseplate prevents the Patient from moving the unit, causing image distortions and **makes both, Patient and Panoramic, more stable**.

## 7-INCH COLOUR TOUCHSCREEN

From the wide screen, Operator has access to all commands and functions, in order to easily configure Panoramic during Patient Positioning phase. Workflow is facilitated by control panel with its ergonomic design and **intuitive symbols**; screen size is ideal to quickly view icons and browse the menu.

## PANRAD MULTI-UTENTE

OPERA is provided with PANRAD, the Software for image processing and management: despite its complete range of functions, **PANRAD is extremely easy to use** and helps Operator in OPERA's utilization.

## FR CLAIR DIAGNOSTIC DÈS LA PREMIÈRE RADIOGRAPHIE

OPERA c'est le système intégré d'acquisition et de gestion des images numériques 2D, 3D et céphalométriques en haute définition. C'est un panoramique numérique facile à utiliser qui garantit des images de haute qualité, parfait pour **un diagnostic clair et précis dès la première radiographie**.

## GENERATEUR DE HAUTE FREQUENCE AVEC POINT FOCAL DE 0,5 MM

OPERA **empêche l'émission de radiations inutiles** grâce au **générateur haute fréquence** à émission pulsée de **point focale de 0,5 mm**. Avec OPERA de New Life Radiology, l'acquisition d'images haute définition avec une rotation de 230 degrés s'effectue **en seulement 15 secondes**.

## POSITIONNEMENT RAPIDE ET STABLE POUR UN RÉSULTAT PLUS PRÉCIS

Le positionnement du patient est rapide et facile. La morsure, la mentonnière et les rayons laser assurent un centrage parfait. Le miroir aide l'opérateur à effectuer le positionnement rapidement et correctement. OPERA de New Life Radiology accorde une attention particulière au positionnement: **un alignement correct du patient détermine une meilleure qualité d'image, moins de temps pour l'examen et une réduction de l'exposition aux rayons**.

## BASE MÉTALLIQUE AUTOPORTEUR

Une plus grande stabilité est synonyme d'images de meilleure qualité. Dans ce contexte, la base métallique autoporteur d'OPERA empêche le patient de bouger, ce qui provoque une distorsion de l'image et **rend le patient et le Panoramic plus stables**.

## ECRAN TACTILE 7 POUCES EN COULEURS

À partir du grand écran, l'opérateur a accès à toutes les commandes et fonctions pour configurer facilement le panoramique pendant la phase de positionnement du patient. Le panneau de commande ergonomique doté de **symboles intuitifs** facilite le flux de travail; la taille de l'écran est idéale pour afficher rapidement des icônes et naviguer dans le menu.

## PANRAD MULTI-UTILISATEUR

OPERA est fourni avec PANRAD, le logiciel de traitement et de gestion d'images: malgré sa gamme complète de fonctions, **PANRAD est extrêmement facile à utiliser** et aide l'opérateur à utiliser OPERA.

## IT UPGRADE: DECIDI TU "SE" E "QUANDO"

Il Panoramico OPERA è sempre pronto a rispondere ai tuoi bisogni. Puoi scegliere OPERA 2D e decidere successivamente di passare al modello 3D oppure a quello CEPH.

La versione Upgradable di OPERA, ti offre infatti l'accesso a quattro diverse configurazioni:

## UK UPGRADE: YOU DECIDE "IF" AND "WHEN"

OPERA is always ready to answer to your needs. You can easily start with the entry-level unit (OPERA 2D) and then decide to move towards the 3D or CEPH unit. The OPERA Upgradable configuration gives you access to four different configurations:

## FR MISE À NIVEAU: DECIDEZ VOUS "SI" ET "QUAND"

Le Panoramic OPERA est toujours prêt à répondre à vos besoins. Vous pouvez choisir OPERA 2D et puis décider de passer au modèle 3D ou au modèle CEPH.

La version évolutive d'OPERA vous donne accès à quatre configurations différentes:

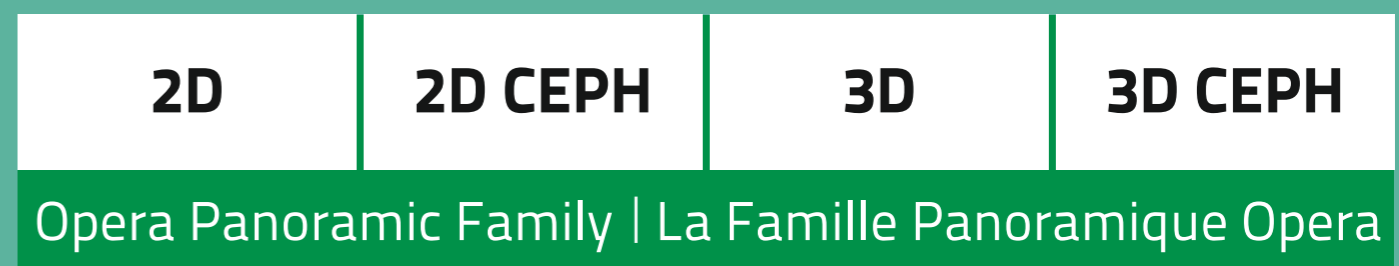

OPERA 2D UPGRADABLE

CEPH

OPERA 2D CEPH

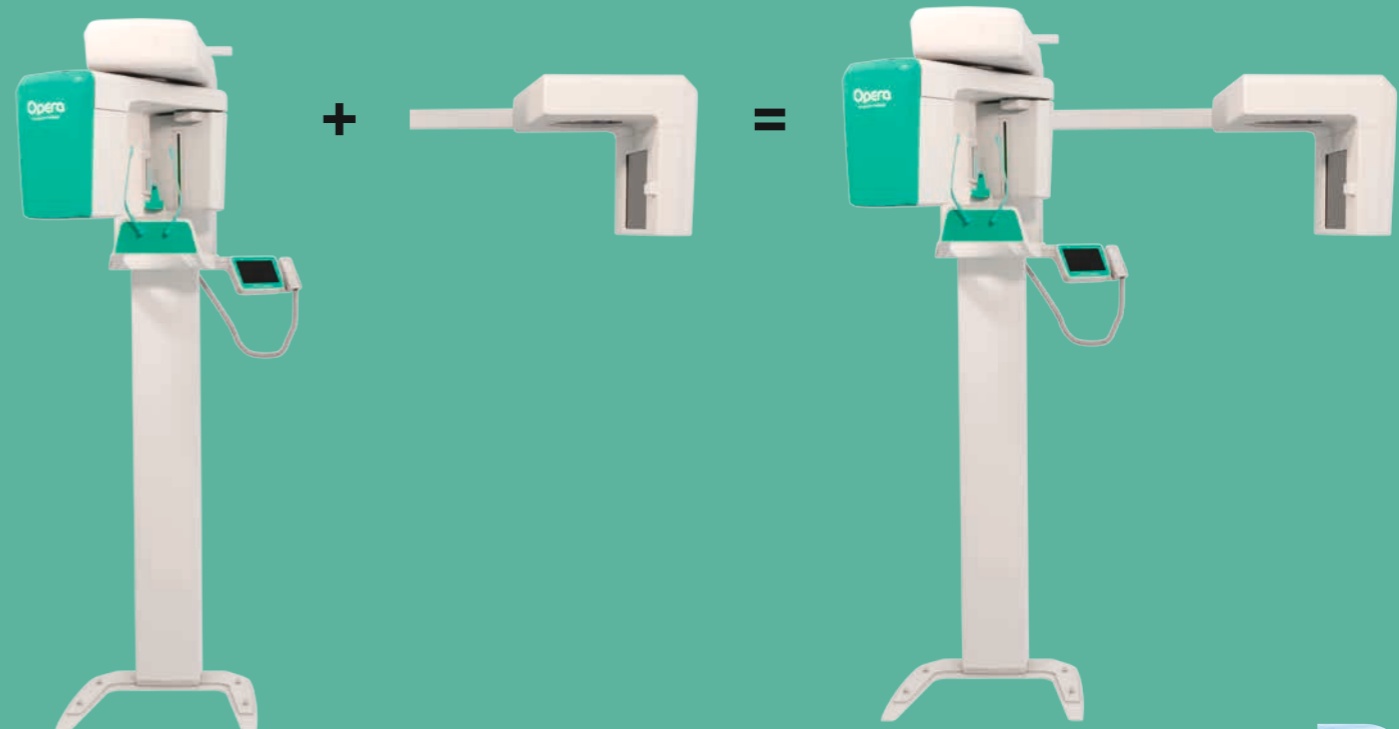





# Opera

LA FAMIGLIA DI SOLUZIONI PANORAMICHE | THE FAMILY OF PANORAMIC SOLUTIONS | LA FAMILLE DES SOLUTIONS PANORAMIQUES

## OPERA 2D

LA PERFEZIONE IN DUE DIMENSIONI  
FULL PERFECTION IN 2D  
LA PERFECTION EN DEUX DIMENSIONS



### OPERA 2D Alta qualità delle immagini anche senza CEPH

La Famiglia OPERA inizia da OPERA 2D: grazie al suo design pulito ed ergonomico, OPERA 2D si adatta perfettamente al Vostro spazio di lavoro ed offre uno sviluppo di alto livello tecnologico per l'acquisizione di immagini 2D nitide:

- Tempo d'esposizione di 14.3 s per i bambini e di 15 s per gli adulti
- Generatore DC ad alta frequenza
- Area attiva di 151 x 6.9 mm
- Immagini in alta definizione di 15 x 30 cm
- Macchia focale di 0.5 mm
- Sensore TDI CCD

### OPERA 2D High Quality Images even without CEPH

The OPERA family begins with OPERA 2D: thanks to its clean and ergonomic design, OPERA 2D perfectly fits into your workspace and offers high-level technological development for the acquisition of clear 2D images:

- Exposure time of 14.3 s for children and 15 s for adults
- DC high frequency generator
- 151 x 6.9 mm Active Area
- 15 x 30 cm HD images
- 0.5 mm focal spot
- Sensor TDI CCD

### OPERA 2D Qualité d'image élevée, même sans CEPH

La famille OPERA commence avec OPERA 2D: grâce à son design épuré et ergonomique, OPERA 2D s'adapte parfaitement à votre espace de travail et offre un haut niveau de développement technologique pour l'acquisition d'images 2D claires:

- 14,3 secondes pour les enfants et 15 secondes pour les adultes
- Générateur DC haute fréquence
- Zone active de 151 x 6,9 mm
- Images haute définition de 15 x 30 cm
- Point focale de 0.5mm
- Capteur TDI CCD









 PROGRAMMI STANDARD DEL PANORAMICO 2D

 OPERA 2D STANDARD PROGRAMS

 PROGRAMMES PANORAMIQUES 2D STANDARD

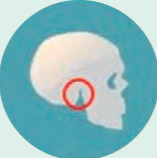
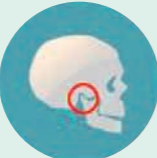
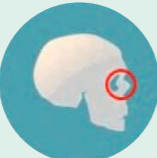
<p><b>Panoramica Standard</b> Standard Panoramic Panoramique Standard</p>		<p>Esame panoramico adulto/bambino Adult/Child panoramic exam Examen panoramique adulte/enfant</p>
<p><b>Emi Panoramica Destra</b> Hemi Panoramic Right Emi Panoramique Droite</p>		<p>Panoramica segmentata acquisita solo sul lato destro Segmented panoramic acquired only on the right side Panoramique segmentée acquise uniquement sur le côté droit</p>
<p><b>Emi Panoramica Sinistra</b> Hemi Panoramic Left Emi Panoramique Gauche</p>		<p>Panoramica segmentata acquisita solo sul lato sinistro Segmented panoramic acquired only on the left side Panoramique segmentée acquise uniquement sur le côté gauche</p>
<p><b>Dentizione Frontale</b> Frontal Dentition Dentition frontale</p>		<p>Panoramica limitata alla dentizione frontale (da canino a canino) Panoramic limited to the frontal dentition (canine to canine) Panoramique limitée à la dentition frontale (de canine à canine)</p>
<p><b>ATM bocca chiusa</b> TMJ closed mouth TMJ bouche fermée</p>		<p>Condilo sinistro/destro, bocca chiusa Left/right condyle, close mouth Conduite gauche/droite, bouche fermée</p>
<p><b>ATM bocca aperta</b> TMJ open mouth Bouche ouverte</p>		<p>Condilo sinistro/destro, bocca aperta Left/right condyle, open mouth Conduite gauche/droite, bouche ouverte</p>
<p><b>Sinus</b></p>		<p>Proiezione, in cui sono rappresentati entrambi i seni paranasali Projection, where both the maxillary sinuses are represented Projection dans laquelle sont représentés les deux sinus paranasaux</p>

MODALITÀ DIVERSE DI CATTURA DELLE IMMAGINI PER UNA DIAGNOSI FACILE ED EFFICIENTE  
VARIOUS CAPTURE MODES FOR AN EASY AND EFFICIENT DIAGNOSIS  
DIFFÉRENTS MODES DE CAPTURE D'IMAGES POUR UN DIAGNOSTIC FACILE ET EFFICACE

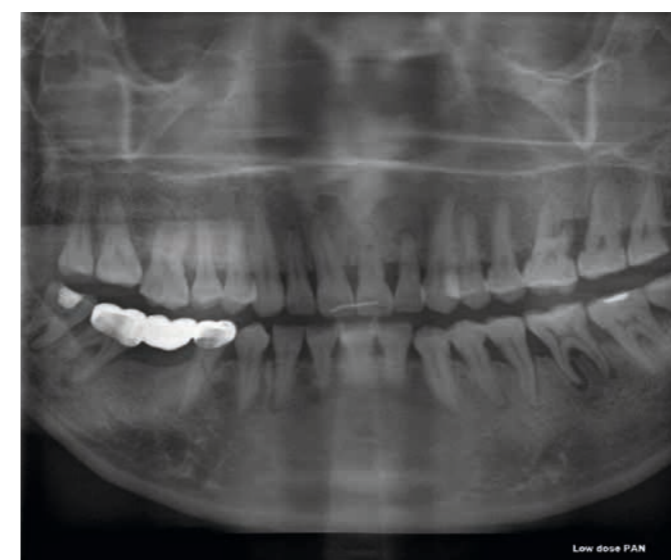
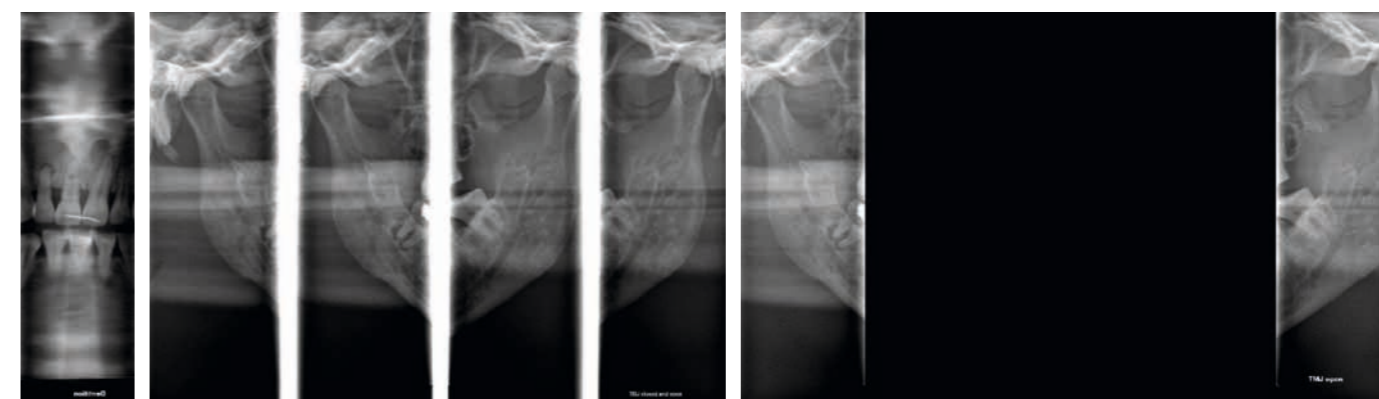
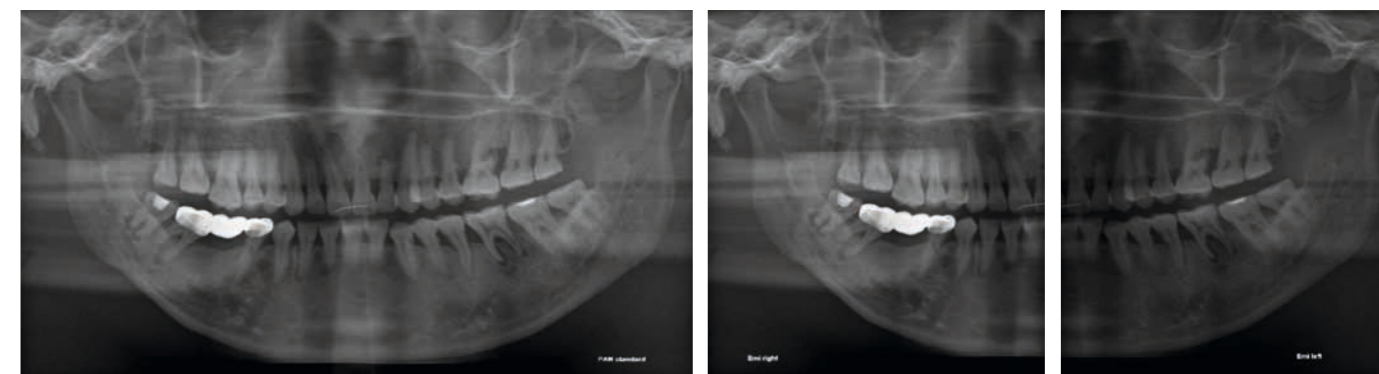

**OPERA 2D è disponibile in due versioni:**

- la configurazione standard, non Upgradable, che resta originale nelle sue funzioni PAN
- la versione Upgradable, pensata per consentire l'evoluzione ai modelli 3D e/o CEPH

**OPERA 2D is available in two versions:**

- the standard configuration, not Upgradable, which remains original in its PAN functions
- the Upgradable version, which is adapted to allow the evolution to 3D and/or CEPH models

**OPERA 2D est disponible en deux versions:**

- la configuration standard, non Evolutive, qui reste originale dans ses fonctions PAN
- la version Evolutive, conçue pour permettre l'évolution vers les modèles 3D et/ou CEPH

 **PROGRAMMI OPZIONALI**

- Panoramica Dose Ridotta
- Panoramica Ortogonalità migliorata
- Bitewing Destra
- Bitewing Sinistra
- Bitewing Destra e Sinistra

 **OPTIONAL PROGRAMS**

- Reduced Dose Panoramic
- Improved Orthogonality Panoramic
- Bitewing Right
- Bitewing Left
- Bitewing Right and Left

 **PROGRAMMES OPTIONNELS**

- Dose réduite Panoramique
- Panoramique Orthogonalité améliorée
- Bitewing Droite
- Bitewing Gauche
- Bitewing Droite et Gauche

# Opera

LA FAMIGLIA DI SOLUZIONI PANORAMICHE | THE FAMILY OF PANORAMIC SOLUTIONS | LA FAMILLE DES SOLUTIONS PANORAMIQUES

# OPERA 2D CEPH

DUE SENSORI, UN UNICO SCATTO  
DOUBLE SENSORS, SINGLE SHOT  
DEUX CAPTEURS, COUP UNIQUE

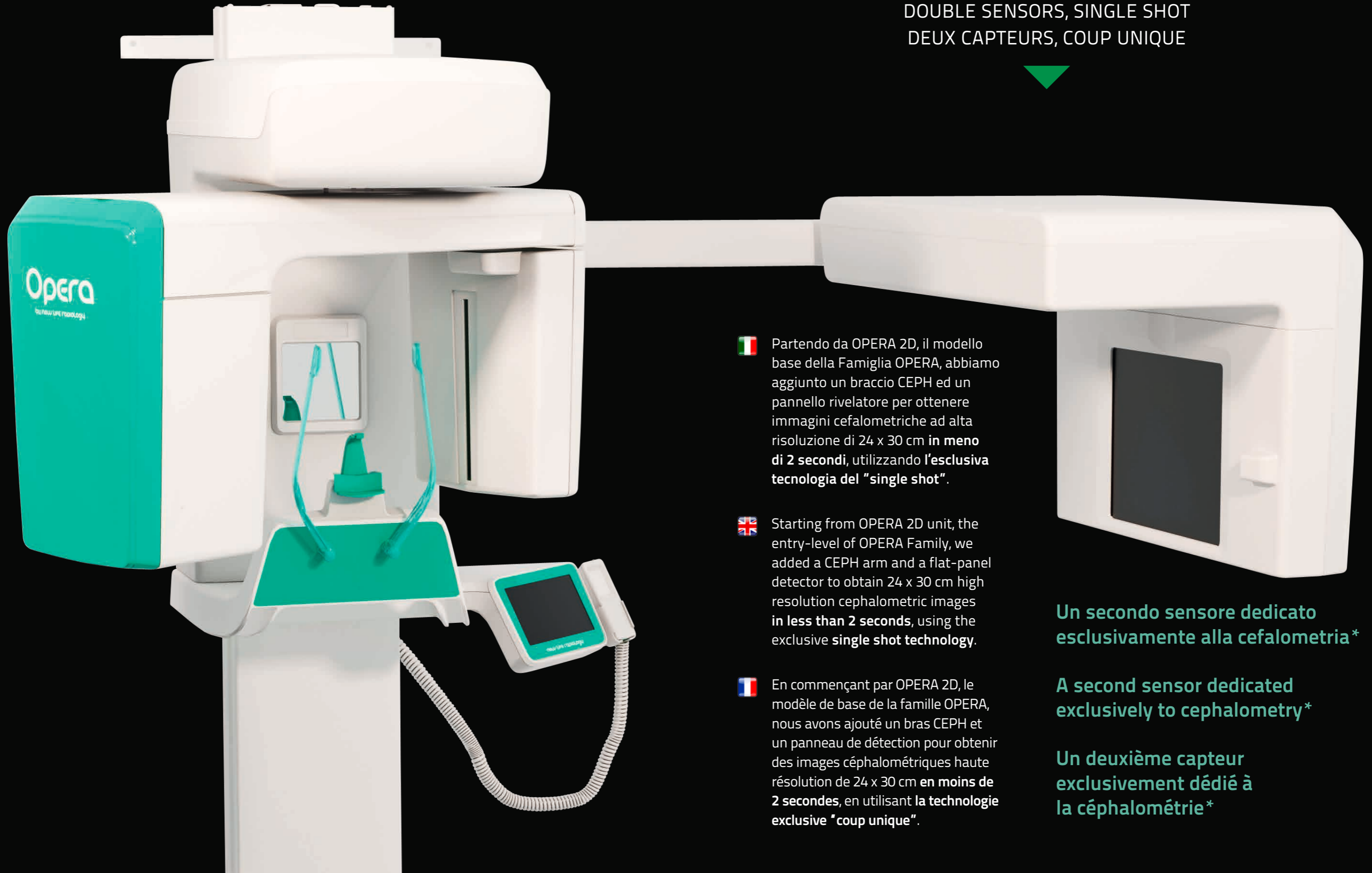

 Partendo da OPERA 2D, il modello base della Famiglia OPERA, abbiamo aggiunto un braccio CEPH ed un pannello rivelatore per ottenere immagini cefalometriche ad alta risoluzione di 24 x 30 cm **in meno di 2 secondi**, utilizzando l'**esclusiva tecnologia del "single shot"**.

 Starting from OPERA 2D unit, the entry-level of OPERA Family, we added a CEPH arm and a flat-panel detector to obtain 24 x 30 cm high resolution cephalometric images **in less than 2 seconds**, using the exclusive **single shot technology**.

 En commençant par OPERA 2D, le modèle de base de la famille OPERA, nous avons ajouté un bras CEPH et un panneau de détection pour obtenir des images céphalométriques haute résolution de 24 x 30 cm **en moins de 2 secondes**, en utilisant la **technologie exclusive "coup unique"**.

**Un secondo sensore dedicato esclusivamente alla cefalometria\***

**A second sensor dedicated exclusively to cephalometry\***

**Un deuxième capteur exclusivement dédié à la céphalométrie\***



## SINGLE SHOT

Mentre altre unità utilizzano un sistema di scannerizzazione con tempo d'esposizione di 15 secondi, OPERA 2D CEPH riduce in maniera significativa il tempo di esposizione, senza che ciò influisca sulla qualità dell'immagine (con **un single shot in meno di 2s**). Il Sistema Single Shot previene le complicanze derivanti dal movimento durante lo scanning delle immagini.

## SINGLE SHOT TECHNOLOGY





While other units use a scanning system with an exposure time of 15 seconds, OPERA 2D CEPH, reduces significantly the exposure time without affecting the quality of the image (taking **a single shot in less than 2s**). The Single Shot System prevents the complications deriving from movement when obtaining images by scanning.

## COUP UNIQUE

Tandis que d'autres unités utilisent un système de numérisation avec un temps d'exposition de 15 secondes, OPERA 2D CEPH réduit considérablement le temps d'exposition, sans affecter la qualité de l'image (avec **une coup unique en moins de 2s**). Le système **Coup Unique** prévient les complications liées aux mouvements lors de la numérisation d'images.



## PROGRAMMI CEPH | CEPH PROGRAMS | PROGRAMMES CEPH

<b>CEPH LL 30 x 24</b>		Immagine cefalometrica L-L 30x24 L-L Cephalometric 30x24 image Image céphalométrique L-L 30x24
<b>CEPH AP</b>		Immagine cefalometrica A-P A-P Cephalometric image Image céphalométrique A-P
<b>Carpus</b>		Immagine Carpus Carpus image Image Carpus
<b>CEPH LL 24 x 24</b>		Immagine cefalometrica L-L 24x24 L-L Cephalometric 24x24 image Image céphalométrique L-L 24x24

### SOLUZIONI AVANZATE D'IMMAGINE PER DIAGNOSI CEFALOMETRICHE

### ADVANCED IMAGE SOLUTION FOR CEPHALOMETRIC DIAGNOSIS

### SOLUTIONS D'IMAGE AVANCÉES POUR LE DIAGNOSTIC CÉPHALOMÉTRIQUE





## PANNELLO RILEVATORE PER IMMAGINI CEPH FLAT PANEL DETECTOR FOR CEPH IMAGES PANNEAU DE DÉTECTION D'IMAGE CEPH

Sensore CEPH\* | CEPH Sensor\* | Capteur CEPH\*



 **OPERA 2D CEPH** offre un **secondo sensore dedicato esclusivamente alla cefalometria**, evitando eventuali incidenti per la caduta del sensore passando da un tipo di esame a un altro. Il sistema si adatta automaticamente alla funzione selezionata.  
È utilizzata la tecnologia esclusiva **Single Shot**, con tempi di esposizione fino a 2 secondi, ottenendo il formato di **24 x 30 cm**.

 **OPERA 2D CEPH** provides a **second sensor exclusively dedicated to cephalometry**, avoiding any accident due to the sensor falling moving from one type of examination to another. The System adapts completely automatically to the selected function.  
The exclusive technology of **Single Shot** allows exposures times till 2 seconds, obtaining the **24 x 30 cm** format.

 **OPERA 2D CEPH** propose un **deuxième capteur exclusivement dédié à la céphalométrie**, évitant ainsi les accidents dus à la chute du capteur d'un type d'examen à un autre. Le système s'adapte automatiquement à la fonction sélectionnée.  
La technologie exclusive **Coup Unique** est utilisée, avec des temps d'exposition allant jusqu'à 2 secondes, permettant d'obtenir le format **24 x 30 cm**.

Lo spostamento del sensore da un tipo di esame all'altro, può causare possibili danni: per questo motivo, OPERA 2D CEPH usa una **seconda rilevazione d'immagini**, un pannello flat con tecnologia CR con lettore d'immagine inclusa. Il Sistema si adatta in maniera totalmente automatica alla funzione selezionata.

Moving the sensors from one type of examination to another, could cause possible damages: for this reason, OPERA 2D CEPH uses a **second image detection**, a CR technology based flat panel with image reader included. The System adapts completely automatically to the selected function.

Le fait de déplacer le capteur d'un type d'examen à un autre peut causer des dommages: pour cette raison, OPERA 2D CEPH utilise une **deuxième détection d'image**, un panneau plat avec technologie CR avec lecteur d'image inclus. Le système s'adapte complètement automatiquement à la fonction sélectionnée.



UN GIORNO CI SARÀ  
UN PANORAMICO CHE CAMBIERÀ  
IL TUO PUNTO DI VISTA:

QUEL GIORNO E' OGGI...

ONE DAY THERE'LL BE  
A PANORAMIC CHANGING  
YOUR POINT OF VIEW:

THAT DAY IS TODAY...

UN JOUR IL Y AURA  
UN PANORAMIQUE QUI  
CHANGERA VOTRE  
POINT DE VUE:

CE JOUR EST AUJOURD'HUI ...





# Opera

LA FAMIGLIA DI SOLUZIONI PANORAMICHE | THE FAMILY OF PANORAMIC SOLUTIONS | LA FAMILLE DES SOLUTIONS PANORAMIQUES

## OPERA 3D

ESPERIENZA FOV PER DIAGNOSI ECCELLENTI  
FOV EXPERIENCE FOR EXCELLENT DIAGNOSIS  
EXPERIENCE CDV POUR UN EXCELLENT DIAGNOSTIC



 New Life Radiology introduce la più avanzata tecnologia CBCT - Tomografia Computerizzata con Cone Beam, la tecnica di imaging biomedico per l'acquisizione delle immagini volumetriche dell'arcata dentale. Il Sistema CBCT rappresenta un valido supporto per la realizzazione di interventi di Implantologia, Chirurgia Generale/Maxillo-Facciale, Parodontologia, Endodonzia e ATM.

- **Pannello Flat CMOS con un'area attiva di 13 x 13 cm e 100nm pixel**
- **FOV (campo di vista) reale 8,5 x 8,5 (non stitching)**
- **Calibrazione geometrica sviluppata recentemente**
- **Funzione di post- processo delle immagini 2D ottenute col sensore 3D**

 New Life Radiology introduces the most advanced CBCT - Cone Beam Computed Tomography - technology, the technic of biomedical imaging for the acquisition of volumetric images of the dental arch. CBCT Sistem represents a valid support for the realization of implantology interventions, general/maxillo-facial surgery, periodontics, endodontics and TMJ.

- **CMOS Flat panel sensor 13 x 13 cm Active Area with 100nm pixel size**
- **Real FOV 8,5 x 8,5 (not stitching)**
- **Recently developed geometrical calibration**
- **Post-process function for 2D images obtained with the 3D sensor**

 New Life Radiology présente la technologie la plus avancée CBCT - la tomographie informatisée Cone Beam - la technique d'imagerie biomédicale pour l'acquisition d'images volumétriques de l'arcade dentaire. Le système CBCT représente un support valable pour la réalisation d'interventions en implantologie, chirurgie générale/maxillo-faciale, parodontie, endodontie et TMJ.

- **Panneau CMOS plat avec une zone active de 13 x 13 cm et des pixels de 100 nm**
- **CDV réel (champ de vue) 8,5 x 8,5 (non assemblage)**
- **Calibration géométrique développée récemment**
- **Fonction de post-traitement des images 2D obtenue avec le capteur 3D**





## 3D Standard Exams | Examen 3D Standard

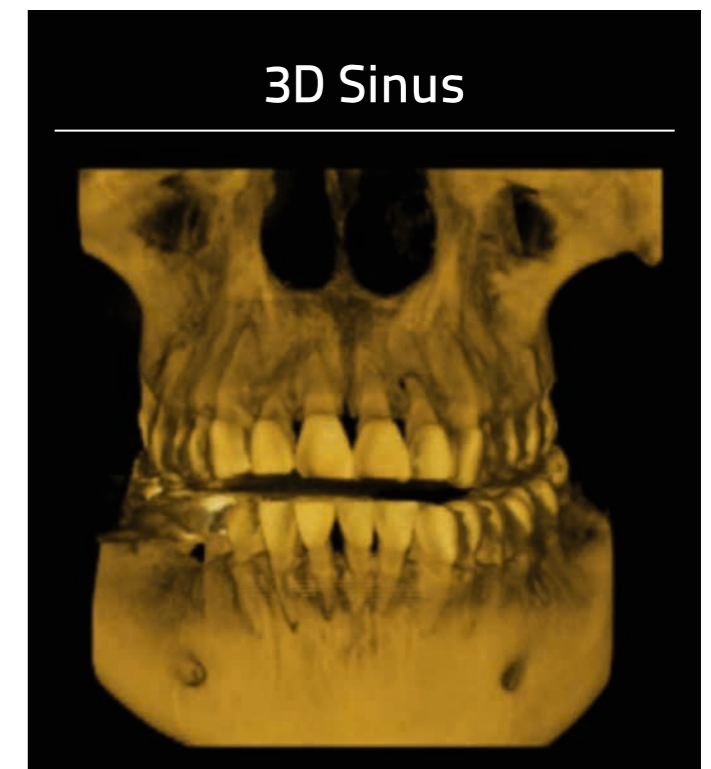
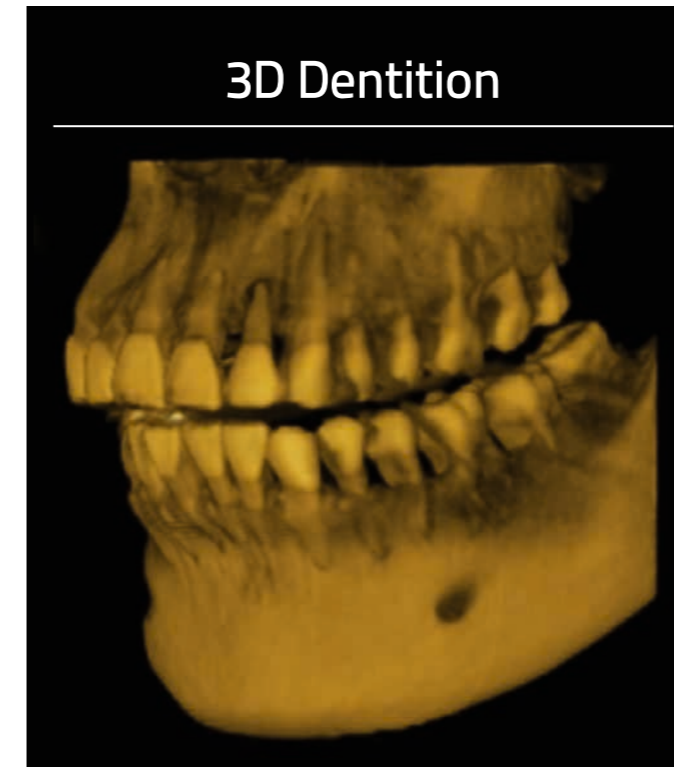

**IT** **STESSO SENSORE PER IMMAGINI 2D E 3D: LA SOLUZIONE 2 IN 1**  
 Un'efficiente soluzione due-in-uno per ottenere immagini 2D 13 x 30cm ed immagini Volumetriche 8,5 x 8,5 cm in soli 10 secondi.  
 Un sensore CMOS flat panel con area attiva di 13 x 13 cm, risoluzione di 100 micron e capacità di cattura di 300 frame: con queste caratteristiche, l'acquisizione di un database immagini ideale per la costruzione volumetrica di un'immagine con FOV (campo di vista) di diametro 8,5 cm x altezza 8,5 cm è garantita.

**UK** **SAME SENSOR FOR 2D AND 3D IMAGES: 2 in 1 SOLUTION**  
 An efficient two-in-one solution to obtain 13 x 30 cm 2D images and 8,5 x 8,5 cm Volumetric Images in just 10 seconds.  
 A CMOS flat panel sensor with 13 x 13 cm active area, 100 micron resolution and capture capacity of 300 frames: with those special features, the acquisition of an ideal images database for volumetric construction of an image with FOV 8,5 cm (diameter) x 8,5 cm (height) is guaranteed.

**FR** **MÊME CAPTEUR D'IMAGES 2D ET 3D: LA SOLUTION 2 EN 1**  
 Une solution efficace deux-en-un pour obtenir des images 2D de 13 x 30 cm et des images volumétriques de 8,5 x 8,5 cm en seulement 10 secondes.  
 Capteur CMOS à panneau plat avec une surface active de 13 x 13 cm, une résolution de 100 microns et une capacité de capture de 300 images: avec ces caractéristiques, l'acquisition d'une base de données d'images idéale pour la construction volumétrique d'une image avec CDV (champ de vue) de diamètre 8,5 cm x hauteur 8,5 cm est garantie.

## IL SOFTWARE PENSATO PER GL'IMPLANTOLOGI THE RIGHT SOFTWARE FOR IMPLANTOLOGISTS LE LOGICIEL PENSÉ POUR LES IMPLANTOLOGUES

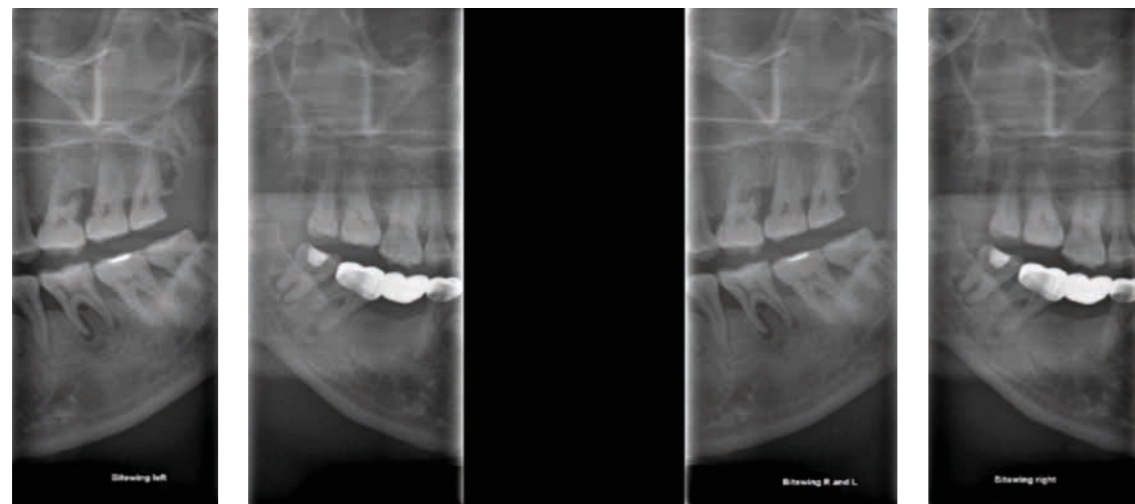
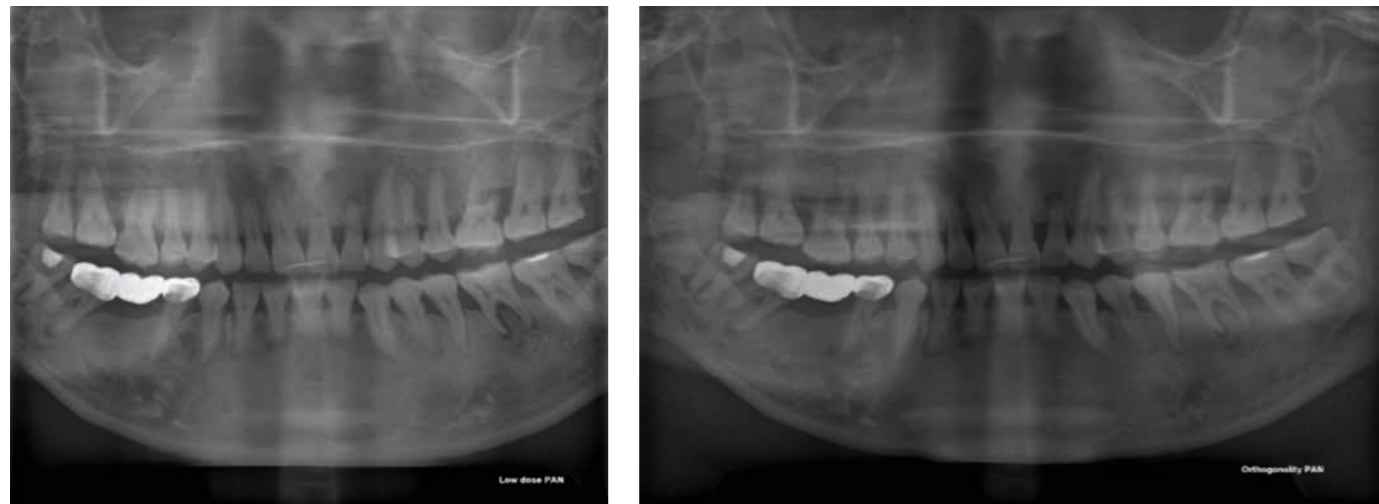

### PROGRAMMI OPZIONALI

- Panoramica Dose Ridotta
- Panoramica Ortogonalità migliorata
- Bitewing Destra
- Bitewing Sinistra
- Bitewing Destra e Sinistra

### OPTIONAL PROGRAMS

- Reduced Dose Panoramic
- Improved Orthogonality Panoramic
- Bitewing Right
- Bitewing Left
- Bitewing Right and Left

### PROGRAMMES OPTIONNELS

- Dose réduite Panoramique
- Panoramique Orthogonalité améliorée
- Bitewing Droite
- Bitewing Gauche
- Bitewing Droite et Gauche

### XELIS SOFTWARE

New Life Radiology pone notevole attenzione alle esigenze degli implantologi. XELIS, il Programma per la pianificazione e simulazione d'implanti, è disponibile in due versioni:

- Xelis Advanced Implant
- Xelis Basic Implant

### XELIS SOFTWARE

New Life Radiology pays a lot of attention to Implantologists needs. XELIS, the Software for implant planning and simulation, is available in two versions:

- Xelis Advanced Implant
- Xelis Basic Implant

### LOGICIEL XELIS

New Life Radiology accorde une grande attention aux besoins des implantologues. XELIS, le programme de planification et de simulation des implants, est disponible en deux versions:

- Xelis Advanced Implant
- Xelis Basic Implant

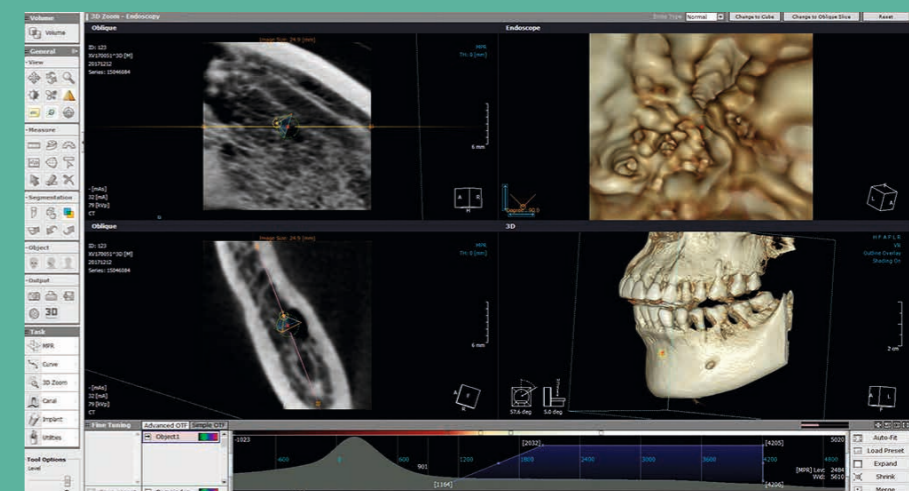
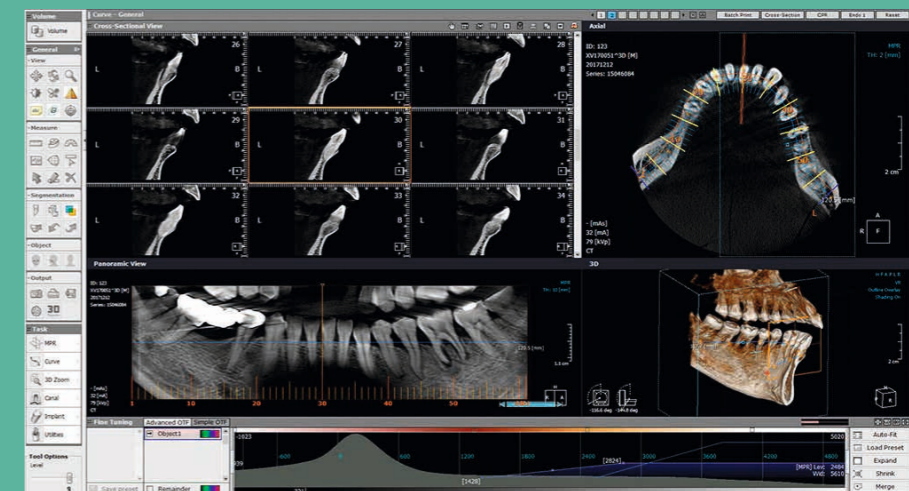





# Opera

LA FAMIGLIA DI SOLUZIONI PANORAMICHE | THE FAMILY OF PANORAMIC SOLUTIONS | LA FAMILLE DES SOLUTIONS PANORAMIQUES

# OPERA 3D CEPH

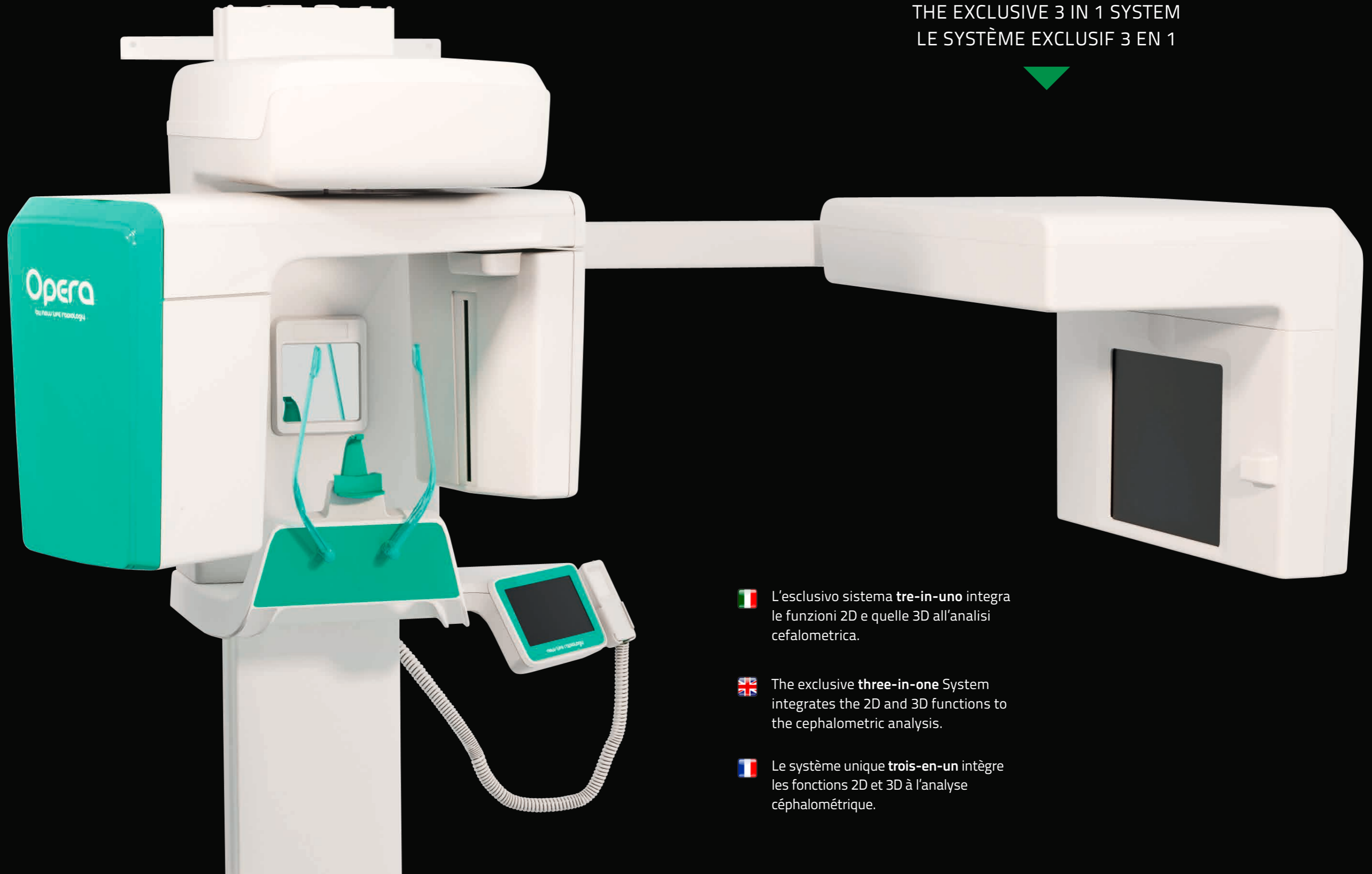
L'ESCLUSIVO SISTEMA 3 IN 1  
THE EXCLUSIVE 3 IN 1 SYSTEM  
LE SYSTÈME EXCLUSIF 3 EN 1



 L'esclusivo sistema **tre-in-uno** integra le funzioni 2D e quelle 3D all'analisi cefalometrica.

 The exclusive **three-in-one** System integrates the 2D and 3D functions to the cephalometric analysis.

 Le système unique **trois-en-un** intègre les fonctions 2D et 3D à l'analyse céphalométrique.

# Opera

 In aggiunta alle caratteristiche del 3D, questo modello è equipaggiato di un **braccio per le immagini cefalometriche** ed il rilevatore CR2430, un pannello flat con tecnologia CR con **lettore d'immagini incorporato** che ottiene immagini cefalometriche in alta definizione 24 x 30cm in meno di **2 secondi**, utilizzando la tecnologia del "single shot".

- Flat Panel CMOS con un'area attiva di 13 x 13 cm e 100nm pixel
- Vero FOV 8,5 x 8,5 (not stitching)
- Immagini cefalometriche 24 x 30 cm in HD
- Immagini volumetriche 8,5 x 8,5
- 13 x 30 cm in 2D

 In addition to the features of the 3D, this model is equipped with an **arm for cephalometric images** and the CR 2430 detector, a CR technology based flat panel with **incorporated image reader** that allows obtaining 24 x 30 cm high-definition cephalometric images in **less than 2 seconds**, using the single-shot technology.

- CMOS Flat panel sensor 13 x 13 cm active area with 100nm pixel size
- Real FOV 8,5 x 8,5 (not stitching)
- 24 x 30 cm HD cephalometric images
- 8,5 x 8,5 volumetric images
- 13 x 30 cm 2D

 Outre les fonctionnalités 3D, ce modèle est équipé d'un **bras pour images céphalométrique** et du détecteur CR2430, d'un panneau plat à technologie CR avec **lecteur d'images intégré** permettant d'obtenir des images céphalométriques haute définition 24 x 30 cm en **moins de 2 secondes**, en utilisant la technologie "coup unique".

- CMOS panneau plat avec une zone active de 13 x 13 cm et des pixels de 100 nm
- CDV réel 8,5 x 8,5 (non assemblage)
- Images céphalométriques 24 x 30 cm en HD
- 8,5 x 8,5 images volumétriques
- 13 x 30 cm en 2D

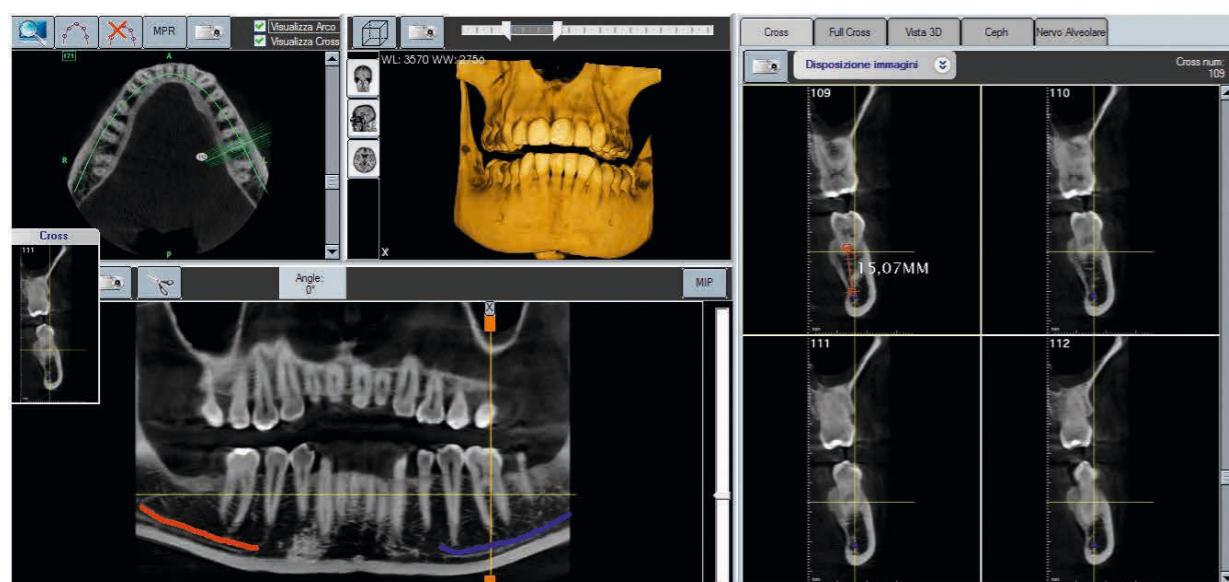
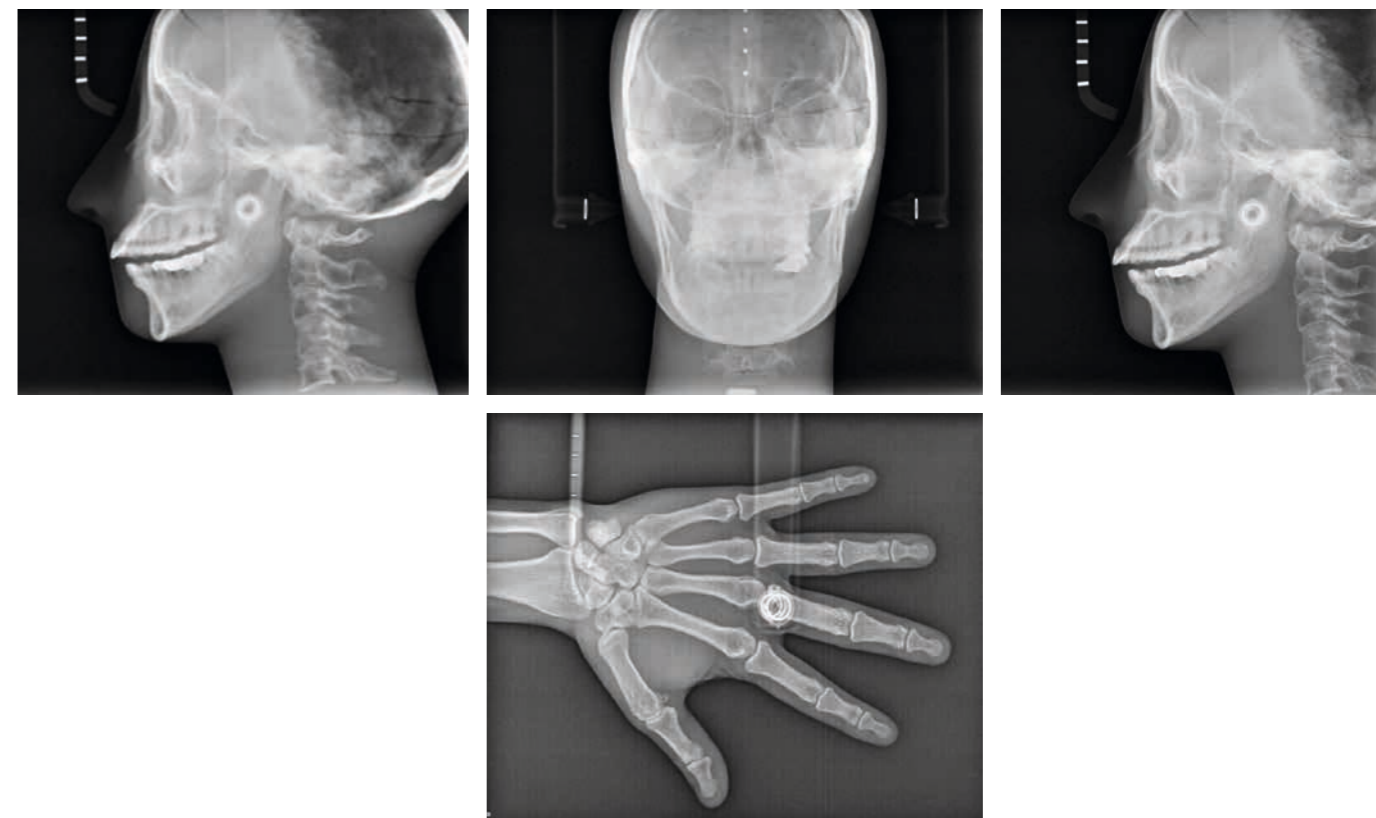



## XELIS:

### IL SOFTWARE PER LA PIANIFICAZIONE DEGLI IMPIANTI IMPLANT PLANNING SOFTWARE LE LOGICIEL DE PLANIFICATION IMPLANTAIRE



 Uno strumento unico che ti assiste nella chirurgia dell'impianto:

- Rileva sezioni trasversali dell'arcata dentaria per una valutazione preliminare dell'impianto e degli sviluppi successivi
- Indica chiaramente la corretta posizione e misura dell'impianto da utilizzare
- Visualizza con precisione i canali nervosi e determina l'angolo dell'intervento chirurgico con maggiore efficacia

 A unique tool to assist you in implant surgery:

- Takes transversal cross sections of the dental arch for preliminary implant evaluation and follow up
- Clearly indicates the correct position and size of the implants to use
- Visualizes with precision the nerve channels and determines the angle for the surgery with greater effectiveness

 Un outil unique qui vous assiste dans la chirurgie implantaire:

- Détecte les coupes transversales de l'arcade dentaire pour une évaluation préliminaire de l'implant et des développements ultérieurs
- Il indique clairement la position et les mesures correctes du système à utiliser
- Voir les canaux nerveux avec précision et déterminer l'angle de la chirurgie plus efficacement

Xelis è dotato di un'interfaccia semplice che aiuta a valutare numerose patologie cliniche incluse fratture, denti inclusi, parodontite ed ATM.

#### Xelis Advanced Implant

- DBM Xelis Dental Database
- Basic 3D Toolbar - including Measurements Tools, MPR, Cross Section
- Advanced Toolbar - Canal Draq / Implant Simulation / Utilities
- STL export - Save surface
- CD7DVD7USB export - image export to external storage
- Batch Print - One click Image Batch
- Print (Axial, Panoramic, Cross Section)
- DLB - Dynamic Light Box
- Image stitching
- Report - Captured Image
- Management and Report generation
- DICOM Print and CD burning
- Net environment, optional multi user up to 10 users

#### Xelis Basic Implant

- DBM Xelis Dental Database
- Basic 3D Toolbar - including Measurement Tools, MPR, Cross Section
- Advanced Toolbar - Canal Draw/Implant Simulation / Utilities
- Net environment, optional multi user up to 10 users.

Xelis has a simple interface to help evaluating numerous clinical pathologies including fracture, included teeth, periodotitis and TMJ.

#### Xelis Advanced Implant

- DBM Xelis Dental Database
- Basic 3D Toolbar - including Measurements Tools, MPR, Cross Section
- Advanced Toolbar - Canal Draq / Implant Simulation / Utilities
- STL export - Save surface
- CD7DVD7USB export - image export to external storage
- Batch Print - One click Image Batch
- Print (Axial, Panoramic, Cross Section)
- DLB - Dynamic Light Box
- Image stitching
- Report - Captured Image
- Management and Report generation
- DICOM Print and CD burning
- Net environment, optional multi user up to 10 users

#### Xelis Basic Implant

- DBM Xelis Dental Database
- Basic 3D Toolbar - including Measurement Tools, MPR, Cross Section
- Advanced Toolbar - Canal Draw/Implant Simulation / Utilities
- Net environment, optional multi user up to 10 users

Xelis possède une interface simple qui permet d'évaluer de nombreuses pathologies cliniques, notamment les fractures, y compris les dents, la parodontite et TMJ.

#### Xelis Advanced Implant

- Base de données DBM Xelis Dental
- Barre d'outils 3D de base - comprenant les outils de mesure, MPR, coupe transversale
- Barre d'outils avancée - Canal Draq / Simulation d'implant / Utilitaires
- Exportation STL - Économiser de la surface
- CD7DVD7USB export - exportation d'images vers un stockage externe
- Impression par lots - Un clic Image Lot
- Impression (coupe axiale, panoramique, transversale)
- DLB - Boîte à lumière dynamique
- Assemblage d'images
- Rapport - Image capturée
- Gestion et génération de rapports
- Impression DICOM et gravure de CD
- Environnement net, option multi utilisateurs jusqu'à 10 utilisateurs

#### Xelis Basic Implant

- Base de données DBM Xelis Dental
- Barre d'outils 3D de base - comprenant outils de mesure, MPR, coupe transversale
- Barre d'outils avancée - Canal Draw / Simulation d'implant / Utilitaires
- Environnement Net, option multi utilisateurs jusqu'à 10 utilisateurs



The logo for 'Opera by new life radiology' is centered within a light blue circular ring. The word 'Opera' is written in a large, white, sans-serif font, with the 'O' being significantly larger than the other letters. Below 'Opera', the text 'by new life radiology' is written in a smaller, white, lowercase sans-serif font. The background of the slide is a solid teal color with a decorative pattern of overlapping, semi-transparent light blue circles and rounded squares on the left side.

Opera  
by new life radiology

SPECIFICHE TECNICHE  
TECHNICAL SPECIFICATIONS  
CARACTERISTIQUES TECHNIQUES



## OPERA 2D

Sensore Tipo Sensor Type PAN Type de capteur	CCD PAN, con funzionalità TDI CCD, with TDI functionality PAN CCD, avec fonctionnalité TDI
Altezza Height Hauteur	15 cm
Formato immagine Image format Format d'image	15 cm x 30 cm
Tempo di esposizione Exposure time Durée d'exposition	14,3 / 15,0 sec (Bambino / Adulto, PAN standard) 14,3 / 15,0 sec (Child / Adult, Standard PAN) 14.3 / 15.0 sec (Enfant / Adulte, PAN standard)
Gamma dinamica Dynamic range Plage dynamique	14 bit
PROGRAMMI PAN PAN PROGRAMS PROGRAMMES PAN	Panoramico adulto Adult panoramic Panoramique Adulte
	Bambino panoramico Child panoramic Enfant panoramique
	Bitewing
	ATM chiuso / bocca aperta TMJ closed / open mouth TMJ bouche fermée / ouverte
	Sinus
	Panoramica settoriale   Sectorial panoramic   Panoramique sectoriel <ul style="list-style-type: none"> <li>• Emi Panoramic R   Emi Panoramic R   Emi Panoramic R</li> <li>• Emi Panoramic L   Emi Panoramic L   Emi Panoramic L</li> <li>• Pan a bassa dose   Low dose Pan   Pan à faible dose</li> <li>• Orto panoramica   Ortho panoramic   Ortho panoramique <ul style="list-style-type: none"> <li>• Incisivi   Incisors   Incisives</li> <li>• Bitewing R - Bitewing L - Bitewing R + L</li> </ul> </li> </ul>
Selezione del paziente Patient selection Sélection du patient	Adulto / bambino, 3 dimensioni per tutte le modalità Adult / child, 3 size for all modalities Adulte / enfant, taille 3 pour toutes les modalités

## GENERATORE DI RAGGI X X RAY GENERATOR GENERATEUR DE RAYONS X

Tipo di generatore Generator type Type de générateur	DC ad alta frequenza High frequency DC DC haute fréquence
Punto focale Focal spot Point focal	0,5 mm
Filtrazione totale Total filtration Filtration totale	> 2,5 mm Aleq a 70 kV) > 2,5 mm Aleq at 70 kV) > 2,5 mm Aleq à 70 kV)
Radiazione di dispersione Leakage radiation Rayonnement de dispersion	< 0.5 mGy/h a 85 kV 10 mA 15s. duty cycle 1/8 secondo IEC 60601-2-63 < 0.5 mGy/h at 85 kV 10 mA 15s. duty cycle 1/8 according to IEC 60601-2-63 < 0,5 mGy/h à 85 kV 10 mA 15s. cycle de travail 1/8 selon IEC 60601-2-63
Tensione anodica Anodic voltage Tension anodique	61 ÷ 85 kV, passaggio 3 kV 61 ÷ 85 kV, step 3 kV 61 ÷ 85 kV, étape 3 kV
Corrente anodica Anodic current Courant anodique	4 ÷ 10mA 9 gradini 4 ÷ 10mA 9 steps 4 ÷ 10mA 9 étapes
Requisito di alimentazione Power requirement Plage dynamique	230 V, 10 A, monofase, (50/60 Hz) 230V, 10A, single phase, (50/60Hz) 230V, 10A, monophasé, (50/60Hz)
Peso Weight Poids	95 Kg
Dimensioni Dimensions Dimensions	(H x L x P) 2230 mm x 920 mm x 1070 mm (H x W x D) 2230 mm x 920 mm x 1070 mm (H x L x P) 2230 mm x 920 mm x 1070 mm

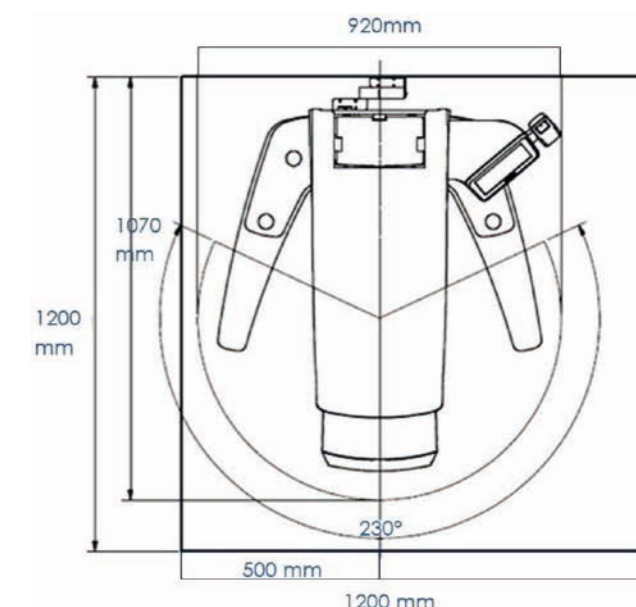
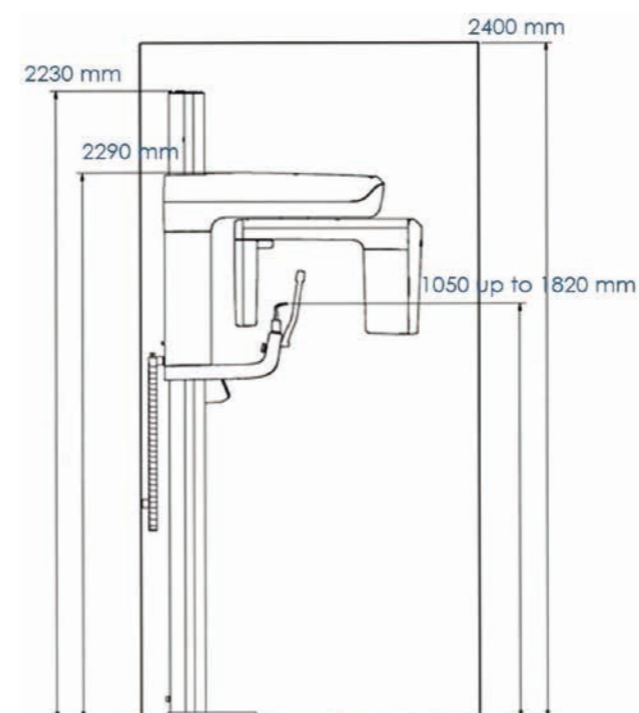

## OPERA 2D CEPH

Sensore Tipo Sensor Type PAN Type de capteur	CCD PAN, con funzionalità TDI CCD, with TDI functionality PAN CCD, avec fonctionnalité TDI
Altezza Height Hauteur	15 cm
Formato immagine Image format Format d'image	15 cm x 30 cm
Tempo di esposizione Exposure time Durée d'exposition	14,3 / 15,0 sec (Bambino / Adulto, PAN standard) 14,3 / 15,0 sec (Child / Adult, Standard PAN) 14.3 / 15.0 sec (Enfant / Adulte, PAN standard)
Gamma dinamica Dynamic range Plage dynamique	14 bit
PROGRAMMI PAN PAN PROGRAMS PROGRAMMES PAN	Panoramico adulto Adult panoramic Panoramique Adulte
	Bambino panoramico Child panoramic Enfant panoramique
	Bitewing
	ATM chiuso / bocca aperta TMJ closed / open mouth TMJ bouche fermée / ouverte
	Sinus
	Panoramica settoriale   Sectorial panoramic   Panoramique sectoriel  <ul style="list-style-type: none"> <li>• Emi Panoramic R   Emi Panoramic R   Emi Panoramic R</li> <li>• Emi Panoramic L   Emi Panoramic L   Emi Panoramic L</li> <li>• Pan a bassa dose   Low dose Pan   Pan à faible dose</li> <li>• Orto panoramica   Ortho panoramic   Ortho panoramique <ul style="list-style-type: none"> <li>• Incisivi   Incisors   Incisives</li> <li>• Bitewing R - Bitewing L - Bitewing R + L</li> </ul> </li> </ul>
Selezione del paziente Patient selection Sélection du patient	Adulto / bambino, 3 dimensioni per tutte le modalità Adult / child, 3 size for all modalities Adulte / enfant, taille 3 pour toutes les modalités

## GENERATORE DI RAGGI X X RAY GENERATOR GENERATEUR DE RAYONS X

Tipo di generatore Generator type Type de générateur	DC ad alta frequenza High frequency DC DC haute fréquence
Punto focale Focal spot Point focal	0,5 mm
Filtrazione totale Total filtration Filtration totale	> 2,5 mm Aleq a 70 kV) > 2,5 mm Aleq at 70 kV) > 2,5 mm Aleq à 70 kV)
Radiazione di dispersione Leakage radiation Rayonnement de dispersion	< 0.5 mGy/h a 85 kV 10 mA 15s. duty cycle 1/8 secondo IEC 60601-2-63 < 0.5 mGy/h at 85 kV 10 mA 15s. duty cycle 1/8 according to IEC 60601-2-63 < 0,5 mGy/h à 85 kV 10 mA 15s. cycle de travail 1/8 selon IEC 60601-2-63
Tensione anodica Anodic voltage Tension anodique	61 ÷ 85 kV, passaggio 3 kV 61 ÷ 85 kV, step 3 kV 61 ÷ 85 kV, étape 3 kV
Corrente anodica Anodic current Courant anodique	4 ÷ 10mA 9 gradini 4 ÷ 10mA 9 steps 4 ÷ 10mA 9 étapes
Requisito di alimentazione Power requirement Plage dynamique	230 V, 10 A, monofase, (50/60 Hz) 230V, 10A, single phase, (50/60Hz) 230V, 10A, monophasé, (50/60Hz)
Peso Weight Poids	95 Kg
Dimensioni Dimensions Dimensions	(H x L x P) 2230 mm x 920 mm x 1070 mm (H x W x D) 2230 mm x 920 mm x 1070 mm (H x L x P) 2230 mm x 920 mm x 1070 mm



## IMMAGINI CEFALOMETRICHE CEPHALOMETRIC IMAGING IMAGERIE CÉPHALOMÉTRIQUE

Tipo di sensore Sensor Type Type de capteur	Piastra al fosforo FLAT PANEL con acquisizione e trasmissione immagini direttamente a bordo (non è necessario rimuovere la piastra al fosforo) FLAT PANEL phosphor plate with direct on-board image acquisition and transmission (no need to remove the phosphor plate) FLAT PANEL avec acquisition et transmission d'images intégrées (pas besoin de retirer la plaque lumineuse)
Formato immagini Image Format Format d'image	24cm x 30cm maximum
Tipo di esposizione Exposure type Type d'exposition	Scatto singolo Single shot Coup unique
Tempo di acquisizione Acquisition time Temps d'acquisition	2s
Impostazione e tempo di esposizione Setting and exposure time Temps de prise et d'exposition	2mAs - 30mAs (0,2-3 s)
PROGRAMMI CEPH CEPH PROGRAMS PROGRAMMES CEPH	L / L P / A A / P Carpus projection   Carpus projection   Projection de carpe
Peso Weight Poids	125 Kg
Dimensioni Dimensions Dimensions	(H x L x P) 2230 mm x 1720 mm x 1070 mm (H x W x D) 2230 mm x 1720 mm x 1070 mm (H x L x P) 2230 mm x 1720 mm x 1070 mm

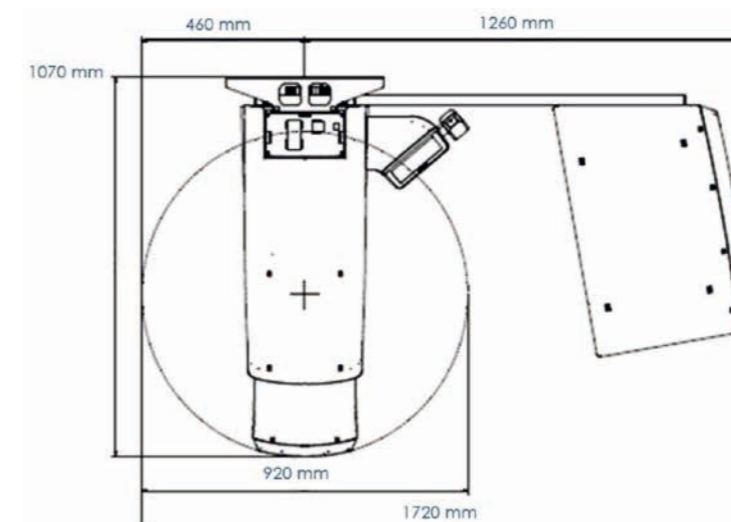
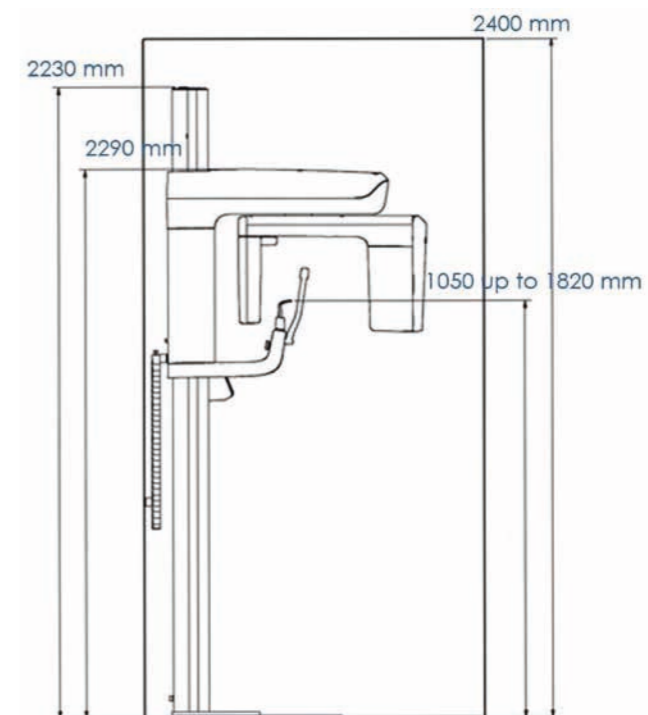



## OPERA 3D

Sensore Tipo Sensor Type PAN Type de capteur	CMOS
Area sensore Sensor Area Surface du capteur	13 x 13 cm
Tempo di esposizione Exposure time Durée d'exposition	14,3 / 15,0 sec (Bambino / Adulto, PAN standard) 14,3 / 15,0 sec (Child / Adult, Standard PAN) 14.3 / 15.0 sec (Enfant / Adulte, PAN standard)
Gamma dinamica Dynamic range Plage dynamique	14 bit
PROGRAMMI PAN IMAGING PAN IMAGING PROGRAMS PROGRAMMES DE PAN IMAGING	Panoramici per adulti Adult panoramic Panoramique Adulte
	Bambino panoramico Child panoramic Enfant panoramique
	Opzione PAN a 3 livelli Option 3 layer focal PAN Option 3 couche focale PAN
	ATM chiuso / bocca aperta TMJ closed / open mouth TMJ bouche fermée / ouverte
	Sinus
	Panoramica settoriale   Sectorial panoramic   Panoramique sectoriel  <ul style="list-style-type: none"> <li>• Emi Panoramic R   Emi Panoramic R   Emi Panoramic R</li> <li>• Emi Panoramic L   Emi Panoramic L   Emi Panoramic L</li> <li>• Pan a bassa dose   Low dose Pan   Pan à faible dose</li> <li>• Orto panoramica   Ortho panoramic   Ortho panoramique <ul style="list-style-type: none"> <li>• Incisivi   Incisors   Incisives</li> <li>• Bitewing R - Bitewing L - Bitewing R + L</li> </ul> </li> </ul>
Selezione del paziente Patient selection Sélection du patient	Adulto / bambino, 3 dimensioni per tutte le modalità Adult / child, 3 size for all modalities Adulte / enfant, taille 3 pour toutes les modalités

## GENERATORE DI RAGGI X X RAY GENERATOR GENERATEUR DE RAYONS X

Tipo di generatore Generator type Type de générateur	DC ad alta frequenza High frequency DC DC haute fréquence
Punto focale Focal spot   Point focal	0,5 mm
Filtrazione totale Total filtration Filtration totale	> 2,5 mm Aleq a 70 kV) > 2,5 mm Aleq at 70 kV) > 2,5 mm Aleq à 70 kV)
Radiazione di dispersione Leakage radiation Rayonnement de dispersion	< 0.5 mGy/h a 85 kV 10 mA 15s. duty cycle 1/8 secondo IEC 60601-2-63 < 0.5 mGy/h at 85 kV 10 mA 15s. duty cycle 1/8 according to IEC 60601-2-63 < 0,5 mGy/h à 85 kV 10 mA 15s. cycle de travail 1/8 selon IEC 60601-2-63
Tensione anodica Anodic voltage Tension anodique	61 ÷ 85 kV, passaggio 3 kV 61 ÷ 85 kV, step 3 kV 61 ÷ 85 kV, étape 3 kV
Corrente anodica Anodic current Courant anodique	4 ÷ 10mA 9 gradini 4 ÷ 10mA 9 steps 4 ÷ 10mA 9 étapes
Requisito di alimentazione Power requirement Puissance exigence	230 V, 10 A, monofase, (50/60 Hz) 230V, 10A, single phase, (50/60Hz) 230V, 10A, monophasé, (50/60Hz)
Peso   Weight   Poids	95 Kg
Dimensioni Dimensions Dimensions	(H x L x P) 2230 mm x 920 mm x 1070 mm (H x W x D) 2230 mm x 920 mm x 1070 mm (H x L x P) 2230 mm x 920 mm x 1070 mm

## IMMAGINI 3D | 3D IMAGING | IMAGERIE 3D

Modalità di imaging Imaging modalities Modalités d'imagerie	Dentizione, TMJ R, TMJ L Dentition, TMJ R, TMJ L Dentition, TMJ R, TMJ L
Campo visivo Field of view Champ de vision	8,5 cm x 8,5 cm (altezza x diametro) 8,5cm x 8,5cm (height x diameter) 8,5 cm x 8,5 cm (hauteur x diamètre)
Dimensione del pixel del rivelatore Detector pixel size Décteur de taille de pixel	100µm (200µm nel binning 2 x 2) 100µm ( 200µm in binning 2x2) 100µm (200µm en binning 2 x 2)
Dimensione del voxel   Voxel size   Taille du voxel	160 µm
Tasso di acquisizione   Acquisition rate Taux d'acquisition	2 fotogrammi per grado   2 frames per degree 2 images par degré
Rotazione testata del tubo Tube head rotation   Rotation de la tête du tube	230 °
Range dinamico   Dynamic range Plage dynamique	14 bit gray level (max 16.384) Plage dynamique niveau de gris 14 bits (max 16.384)
N. di frame acquisiti   N. of acquired frames Nombre d'images acquises	460
Scan time / Exp.time	15s. / 9,2s.
Tempo di ricostruzione 3D   3D reconstruction time Temps de reconstruction 3D	<10s.





## OPERA 3D CEPH

Sensore Tipo Sensor Type PAN Type de capteur	CMOS
Area sensore Sensor Area Surface du capteur	13 x 13 cm
Tempo di esposizione Exposure time Durée d'exposition	14,3 / 15,0 sec (Bambino / Adulto, PAN standard) 14,3 / 15,0 sec (Child / Adult, Standard PAN) 14.3 / 15.0 sec (Enfant / Adulte, PAN standard)
Gamma dinamica Dynamic range Plage dynamique	14 bit
PROGRAMMI PAN IMAGING PAN IMAGING PROGRAMS PROGRAMMES DE PAN IMAGING	Panoramici per adulti Adult panoramic Panoramique Adulte
	Bambino panoramico Child panoramic Enfant panoramique
	Opzione PAN a 3 livelli Option 3 layer focal PAN Option 3 couche focale PAN
	ATM chiuso / bocca aperta TMJ closed / open mouth TMJ bouche fermée / ouverte
	Sinus
	Panoramica settoriale   Sectorial panoramic   Panoramique sectoriel  <ul style="list-style-type: none"> <li>• Emi Panoramic R   Emi Panoramic R   Emi Panoramic R</li> <li>• Emi Panoramic L   Emi Panoramic L   Emi Panoramic L</li> <li>• Pan a bassa dose   Low dose Pan   Pan à faible dose</li> <li>• Orto panoramica   Ortho panoramic   Ortho panoramique <ul style="list-style-type: none"> <li>• Incisivi   Incisors   Incisives</li> <li>• Bitewing R - Bitewing L - Bitewing R + L</li> </ul> </li> </ul>
Selezione del paziente Patient selection Sélection du patient	Adulto / bambino, 3 dimensioni per tutte le modalità Adult / child, 3 size for all modalities Adulte / enfant, taille 3 pour toutes les modalités

## GENERATORE DI RAGGI X X RAY GENERATOR GENERATEUR DE RAYONS X

Tipo di generatore Generator type Type de générateur	DC ad alta frequenza High frequency DC DC haute fréquence
Punto focale Focal spot   Point focal	0,5 mm
Filtrazione totale Total filtration Filtration totale	> 2,5 mm Aleq a 70 kV) > 2,5 mm Aleq at 70 kV) > 2,5 mm Aleq à 70 kV)
Radiazione di dispersione Leakage radiation Rayonnement de dispersion	< 0.5 mGy/h a 85 kV 10 mA 15s. duty cycle 1/8 secondo IEC 60601-2-63 < 0.5 mGy/h at 85 kV 10 mA 15s. duty cycle 1/8 according to IEC 60601-2-63 < 0,5 mGy/h à 85 kV 10 mA 15s. cycle de travail 1/8 selon IEC 60601-2-63
Tensione anodica Anodic voltage Tension anodique	61 ÷ 85 kV, passaggio 3 kV 61 ÷ 85 kV, step 3 kV 61 ÷ 85 kV, étape 3 kV
Corrente anodica Anodic current Courant anodique	4 ÷ 10mA 9 gradini 4 ÷ 10mA 9 steps 4 ÷ 10mA 9 étapes
Requisito di alimentazione Power requirement Plage dynamique	230 V, 10 A, monofase, (50/60 Hz) 230V, 10A, single phase, (50/60Hz) 230V, 10A, monophasé, (50/60Hz)
Peso   Weight   Poids	95 Kg
Dimensioni Dimensions Dimensions	(H x L x P) 2230 mm x 920 mm x 1070 mm (H x W x D) 2230 mm x 920 mm x 1070 mm (H x L x P) 2230 mm x 920 mm x 1070 mm

## IMMAGINI 3D | 3D IMAGING | IMAGERIE 3D

Modalità di imaging Imaging modalities Modalités d'imagerie	Dentizione, TMJ R, TMJ L Dentition, TMJ R, TMJ L Dentition, TMJ R, TMJ L
Campo visivo Field of view Champ de vision	8,5 cm x 8,5 cm (altezza x diametro) 8,5cm x 8,5cm (height x diameter) 8,5 cm x 8,5 cm (hauteur x diamètre)
Dimensione del pixel del rivelatore Detector pixel size Décteur de taille de pixel	100µm (200µm nel binning 2 x 2) 100µm ( 200µm in binning 2x2) 100µm (200µm en binning 2 x 2)
Dimensione del voxel   Voxel size   Taille du voxel	160 µm
Tasso di acquisizione   Acquisition rate Taux d'acquisition	2 fotogrammi per grado   2 frames per degree 2 images par degré
Rotazione testata del tubo Tube head rotation   Rotation de la tête du tube	230 °
Range dinamico   Dynamic range Plage dynamique	14 bit gray level (max 16.384) Plage dynamique niveau de gris 14 bits (max 16.384)
N. di frame acquisiti   N. of acquired frames Nombre d'images acquises	460
Scan time / Exp.time	15s. / 9,2s.
Tempo di ricostruzione 3D   3D reconstruction time Temps de reconstruction 3D	<10s.

## IMMAGINI CEFALOMETRICHE CEPHALOMETRIC IMAGING IMAGERIE CÉPHALOMÉTRIQUE

Tipo di sensore Sensor Type Capteur Plaque phosphore	Piastra al fosforo FLAT PANEL con acquisizione e trasmissione immagini direttamente a bordo (non è necessario rimuovere la piastra al fosforo) FLAT PANEL phosphor plate with direct on-board image acquisition and transmission (no need to remove the phosphor plate) FLAT PANEL avec acquisition et transmission d'images intégrées (pas besoin de retirer la plaque luminescente)
Formato immagini Image Format Format d'image	24cm x 30cm
Tipo di esposizione Exposure type Type d'exposition	Scatto singolo Single shot Coup unique
Tempo di acquisizione Acquisition time Temps d'acquisition	2s
Impostazione e tempo di esposizione Setting and exposure time Temps de prise et d'exposition	2mAs - 30mAs (0,2-3 s)
PROGRAMMI CEPH CEPH PROGRAMS PROGRAMMES CEPH	L / L P / A A / P
Peso   Weight   Poids	125 Kg
Dimensioni Dimensions Dimensions	(H x L x P) 2230 mm x 1720 mm x 1070 mm (H x W x D) 2230 mm x 1720 mm x 1070 mm (H x L x P) 2230 mm x 1720 mm x 1070 mm







**new LIFE radiology**

HEAD OFFICE & PRODUZIONE  
HEAD OFFICE & PRODUCTION PLANT  
SIÈGE SOCIAL ET USINE DE PRODUCTION

Corso Giuseppe Canonico Allamano 13/15 Int. G  
10095 | Grugliasco (TO) | Italy

[www.newliferadiology.it](http://www.newliferadiology.it)

[info@newliferadiology.it](mailto:info@newliferadiology.it)

DISTRIBUTORE UFFICIALE | AUTHORIZED DEALER | REVENDEUR AGRÉÉ

